

SEE NOTE 4

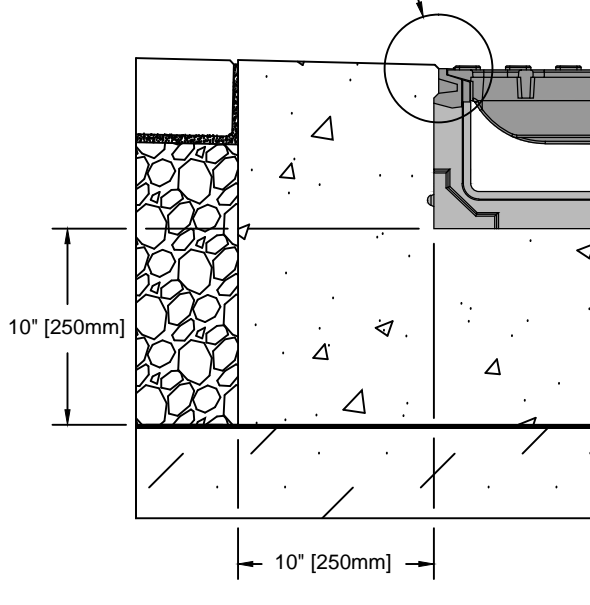

STANDARD INSTALLATION

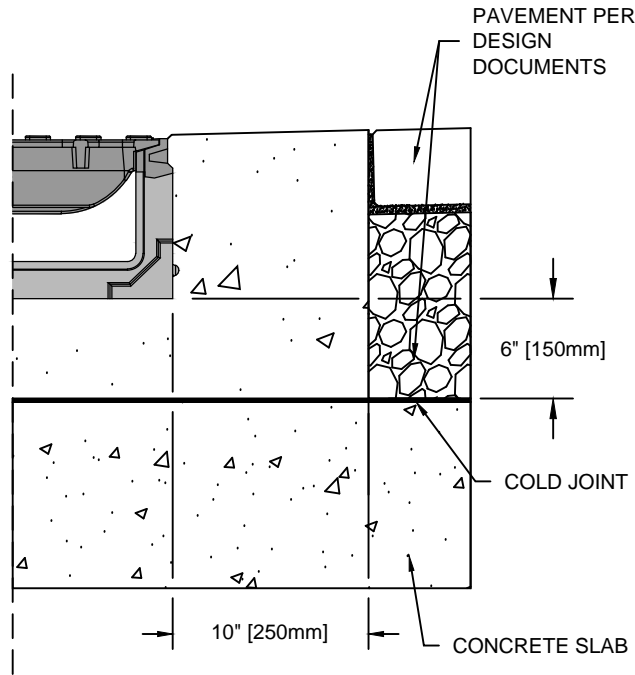

INSTALLATION ON CONCRETE SLAB



NOTES:

1. IT IS NECESSARY TO ENSURE MINIMUM DIMENSIONS SHOWN ARE SUITABLE FOR EXISTING GROUND CONDITIONS. *ENGINEERING ADVICE MAY BE REQUIRED.*
2. MINIMUM CONCRETE STRENGTH OF 4,000 PSI IS RECOMMENDED. CONCRETE SHOULD BE VIBRATED TO ELIMINATE AIR POCKETS.
3. EXPANSION AND CONTRACTION CONTROL JOINTS AND REINFORCEMENT ARE RECOMMENDED TO PROTECT CHANNEL AND CONCRETE SURROUND. *ENGINEERING ADVICE MAY BE REQUIRED.*
4. THE FINISHED LEVEL OF THE CONCRETE SURROUND MUST BE APPROX. 1/8" [3mm] ABOVE THE TOP OF THE CHANNEL EDGE.
5. CONCRETE BASE THICKNESS SHOULD MATCH SLAB THICKNESS. *ENGINEERING ADVICE MAY BE REQUIRED TO DETERMINE PROPER LOAD CLASS.*
6. REFER TO ACO'S LATEST INSTALLATION INSTRUCTIONS FOR FURTHER DETAILS.

SPECIFICATION CLAUSE

H200SK-13 SLABDRAIN - LOAD CLASS E

GENERAL

THE SURFACE DRAINAGE SYSTEM SHALL BE POLYMER CONCRETE H200SK-13 CHANNEL SYSTEM WITH DUCTILE IRON EDGE RAILS AS MANUFACTURED BY ACO POLYMER PRODUCTS, INC.

MATERIALS

CHANNELS SHALL BE MANUFACTURED FROM POLYESTER RESIN POLYMER CONCRETE WITH AN INTEGRALLY CAST-IN DUCTILE IRON EDGE RAIL. MINIMUM PROPERTIES OF POLYMER CONCRETE WILL BE AS FOLLOWS:

| | |
|----------------------------------|------------|
| COMPRESSIVE STRENGTH: | 14,000 PSI |
| FLEXURAL STRENGTH: | 4,000 PSI |
| TENSILE STRENGTH: | 1,500 PSI |
| WATER ABSORPTION: | 0.07% |
| FROST PROOF | YES |
| DILUTE ACID AND ALKALI RESISTANT | YES |
| B117 SALT SPRAY TEST COMPLIANT | YES |

THE SYSTEM SHALL BE 8" (200mm) NOMINAL INTERNAL WIDTH WITH A 10.2" (260mm) OVERALL WIDTH. ALL CHANNELS SHALL BE INTERLOCKING WITH A MALE/FEMALE JOINT.

THE COMPLETE DRAINAGE SYSTEM SHALL BE BY ACO POLYMER PRODUCTS, INC. ANY DEVIATION OR PARTIAL SYSTEM DESIGN AND/OR IMPROPER INSTALLATION WILL VOID ANY AND ALL WARRANTIES PROVIDED BY ACO POLYMER PRODUCTS, INC.

CHANNEL SHALL WITHSTAND LOADING TO PROPER LOAD CLASS AS OUTLINED BY EN 1433. GRATE TYPE SHALL BE APPROPRIATE TO MEET THE SYSTEM LOAD CLASS SPECIFIED AND INTENDED APPLICATION. GRATES SHALL BE SECURED USING 'QUICKLOK' BOLTLESS LOCKING SYSTEM. CHANNEL AND GRATE SHALL BE CERTIFIED TO MEET THE SPECIFIED EN 1433 LOAD CLASS. THE SYSTEM SHALL BE INSTALLED IN ACCORDANCE WITH THE MANUFACTURER'S INSTRUCTIONS AND RECOMMENDATIONS.

H2SK13-E-EPP

H200SK-13 - SLABDRAIN - LOAD CLASS: E
Exposed Paver Pavement

ACO Polymer Products, Inc.



DATE: 08/27/15

INSTALLATION DRAWING - ACO DRAIN

825 W. Beechcraft St
Casa Grande, AZ 85122
Tel: 520-421-9988
Fax: 520-421-9899

9470 Pinecone Dr.
Mentor, OH 44060
Tel: 440-639-7230
Fax: 440-639-7235

4211 Pleasant Rd.
Fort Mill, SC 29708
Tel: 440-639-7230
Fax: 803-802-1063